

BROMIC[®]

Instantaneous Electric Hot Water

Discover our **Electric Hot Water Heaters** range



Energy efficient instantaneous hot water

Bromic Plumbing & Gas is proud to offer a range of electric hot water heating solutions for any home. Delivering immediate hot water to your kitchen and bathroom from our compact, slimline electric hot water heaters. With a history in quality gas and plumbing solutions spanning more than 40 years, our products are backed by technical expertise and understanding of the user's needs. Discover our range and find the ideal solution to suit your needs.

A range of electric hot water solutions

3 Phase Electric Hot Water

2850318 HF-318 | 2850321 HF-321 | 2850324 HF-324 | 2850327 HF-327



5L Compact Storage Electric Water with Mixer Tap

2850001 HF-UH5 | 2850002 HF-OH5 | 2850991



Benefits of Instantaneous Electric Hot Water

Energy efficient water heating.

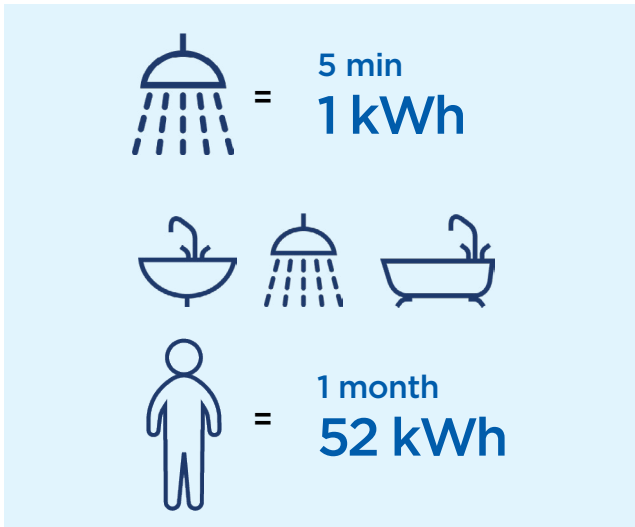

As the water is only heated when the hot water tap is turned on, electric water heaters offer a more energy efficient way to heat water. This ensures low electricity consumption and reduces heat losses.

During a 5 min. shower, you would expect to use around 1kW.

Hot water on demand.

Electric water heaters ensure hot water to your outlet immediately, without the limitation of having hot water stored in a tank. The electric water heater can produce an endless amount of hot water on demand.

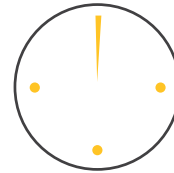

40°C - 3 sec.



In storage water heaters, hot water is limited after the water has been used up, you then need to wait for the tank to refill.



40°C - 1h (50 l)

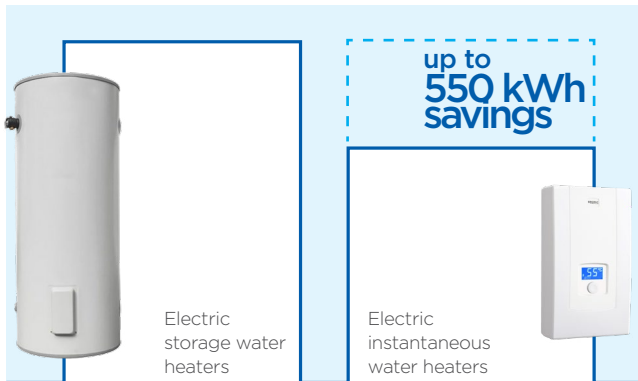
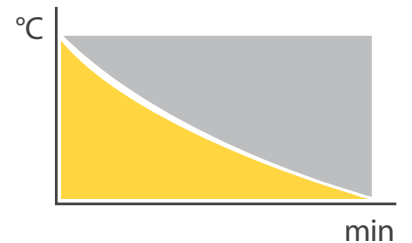

* The average storage water heater with 80l capacity has losses of electricity around 1,5kW/24h, so around 550kWh per year.

Easy to install.

Electric instantaneous water heaters are easy to install and don't require an additional gas connection for the home or building.

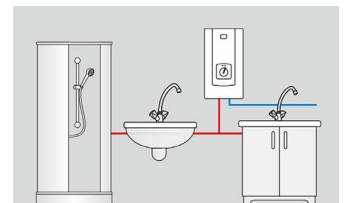

Compact. Sleek design.

The small, compact size of these hot water heaters allows for easy installation near the water outlet (higher water efficiency). This means you avoid the eye-sore of a large hot water tank taking up space.



3 Phase Electric Hot Water

The 3 Phase Instantaneous electric hot water heaters from Bromic Plumbing & Gas are equipped with electronic control and clear LCD display. The 3-phase model supplies water to several water pick-ups, such as the kitchen and bathroom. The electronic water heater is rated 18kW / 21kW / 24kW / 27kW delivering instant hot water to suit your needs. With a temperature range between 30° to 60°C. The temperature lock allows the maximum temperature to be set, and the built in memory function stores the 3 most frequently used temperatures for easy selection.

■ LCD Screen

- + Clearly displays desired outlet temperature
- + Displays inlet and outlet water temperatures, the percentage of max. power the unit currently uses, and the water flow rate.

■ Electronic Control

- + Ensures stability and smooth regulation of the water temperature between 30° to 60°C. With 1°C steps.

■ Temperature Lock

- + Allows the user to set and save the maximum temperature value (Child safety lock).

■ Temperature Memory Function

- + Allows the user to save the 3 most frequently used water temperatures.

■ No Flue required

Applications



Kitchen sink



Shower



Bath



Bathroom sink/basin

Dimensions

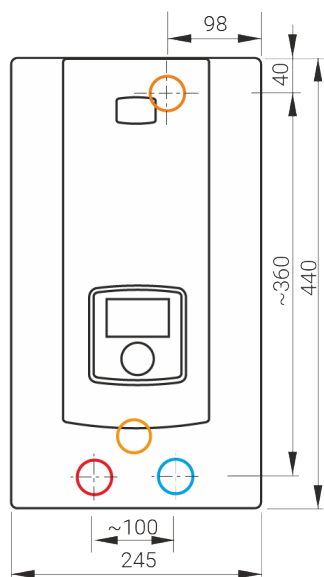

Inlet and outlet section G 1/2"

 cold water inlet

 hot water outlet

 electric cable connection point

3 Phase Range Specifications

Model	HF-318	HF-321	HF-324	HF-327
Product No.	2850318	2850321	2850324	2850327
Type	Instantaneous	Instantaneous	Instantaneous	Instantaneous
Voltage, V	415V	415V	415V	415V
Rated Power, kW	18	21	24	27
Rated Current, A	25.1	29.2	33.4	37.6
Hot Water Delivery, L/min (at $\Delta T = 35^{\circ}\text{C}$)	7.5	8.8	10	11.3
Min. Activation Flow Rate, L/min	2.5	2.5	2.5	2.5
Max Inlet Pressure Rating, kPa	1000	1000	1000	1000
Temperature Range, $^{\circ}\text{C}$	30° - 60°	30° - 60°	30° - 60°	30° - 60°
Dimensions (H x W x D) mm	440 x 245 x 126	440 x 245 x 126	440 x 245 x 126	440 x 245 x 126
Weight, kg	4	4	4	4
IP Rating	IP24	IP24	IP24	IP24
Water Connections	G 1/2" Female	G 1/2" Female	G 1/2" Female	G 1/2" Female
Element Type	Bare Element	Bare Element	Bare Element	Bare Element
Min Water Resistivity, Ω cm (at 15 $^{\circ}\text{C}$)	1100	1100	1100	1100
Pressure Range @ Main Water (MPa)	0.1 - 1	0.1 - 1	0.1 - 1	0.1 - 1
Approvals	WM 40268 (AS 3498)	WM 40268 (AS 3498)	WM 40268 (AS 3498)	WM 40268 (AS 3498)



5L Compact Storage Electric Water Heater



Electronically controlled storage heater, with stainless steel tank designed to ensure quick and easy access to hot water. It is great for installation next to a sink in a laundry, bathroom, or kitchen. This electronic storage hot water heater is energy efficient and compact. The stainless-steel inner tank is resistant to corrosion, with a quick heating time of just 5.5min+ for a full tank.

- **Stainless Steel Tank**
 - + Resistant to corrosion
 - + No need to change anode regularly
- **Comfortable Temperature Control**
 - + With smooth temperature range between 23-70°C
- **Energy Efficient**
 - + With very low energy losses
- **Available in under sink & over sink design**
- **For single point of use/outlet**
- **Comes with vented tap. Also available as unit only.**

Applications



Kitchen sink



Bathroom sink/basin

Pressurised connection to vented mixer tap provided.

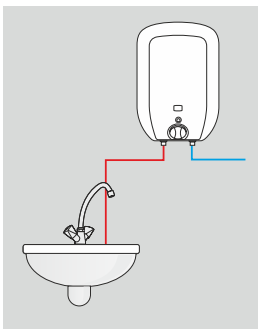

Over Sink

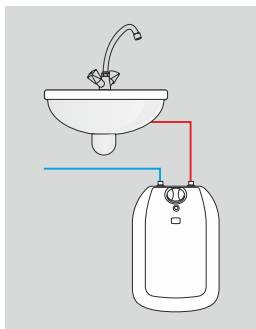

Under Sink

Quick Heating Time



- With immersion heater of 2000W
- Heats 5L in 5.5min at 30°C temperature rise

Dimensions

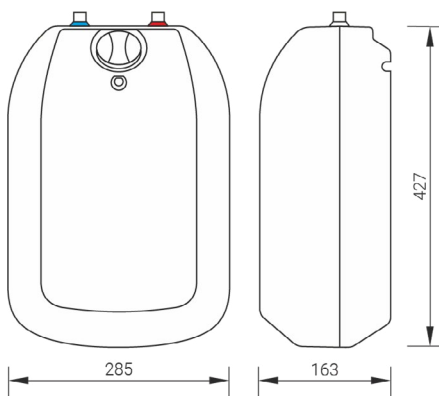

Vented Mixer Tap



Bromic Vented Mixer Tap included with our Bromic Storage Water Heater 5L Underbench kit (HF-UH5)

5L Range Specifications

Model	HF-UH5	HF-OH5
Product No.	2850001	2850002
Mount	Under Sink	Over Sink
Type	Vented Storage	Vented Storage
Voltage, V	240V	240V
Rated Power, kW	2	2
Rated Current, A	8.3 - 9.1	8.3 - 9.1
Max Inlet Pressure Rating, kPa	600	600
Temperature Range, °C	23° - 70°	23° - 70°
Dimensions (H x W x D) mm	427 x 285 x 163	427 x 285 x 163
Weight, kg	4.5	4.5
IP Rating	IP24	IP24
Water Connections	Cold = G 1/2" Male Hot = G 1/2" Male	Cold = G 1/2" Male Hot = G 1/2" Male
Tank Material	Stainless Steel	Stainless Steel
Approvals	WM 40268 (AS 3498)	WM 40268 (AS 3498)

Features

- Stainless steel tank
- Pressurised system
- Electronically controlled





BROMIC[®]

Australia & NZ

10 Phiney Place, Ingleburn NSW 2565 Sydney AUSTRALIA

Visit BROMICHOTWATER.COM email plumbing@bromic.com or call AU 1300 276 642 / NZ 0508 276 642