

Features & Benefits

- Energy efficient
- Booster – choice of electric element or 6-Star continuous flow gas
- Vitreous enamel lined cylinder
- Eligible for STCs⁵
- 5 year cylinder warranty¹

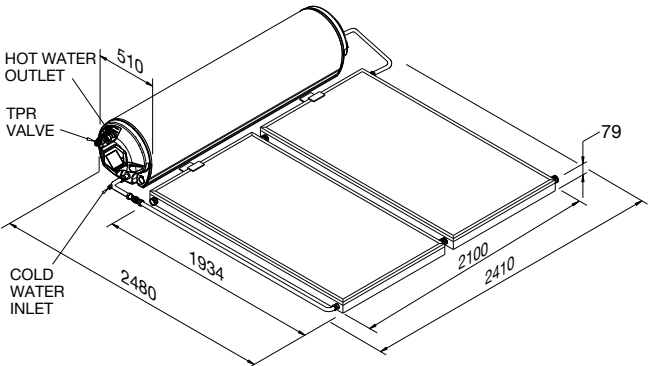

MODEL	52D300
Storage Capacity (L)	300
Solar Collectors	2 NPT200
Booster Type	Electric or gas
Weight Empty (kg) - Tank	92
Hot Water Connection	Rp ³ / ₄
Cold Water Connection	G ¹ / ₂ B



Scan code for details & installation instructions

